

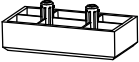

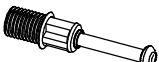

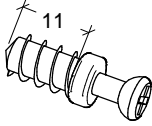





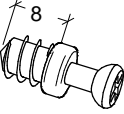

<b>A</b> 5x  BCON045010	<b>B</b> 12x  BBSG270	<b>C</b> 4x  BBSG596	<b>D</b> 12x  BBSG220
<b>E</b> 4x  BBSG597	<b>F</b> 8x  BBSG374	<b>G</b> 8x  BBSG375	<b>H</b> 8x  BVZN11
<b>I</b> 8x  BBSG664	<b>J</b> 4x  BVZN45	<b>K</b> 4x  BSCH512	<b>L</b> 8x  BSCH510
<b>M</b> 2x  BBSG354	<b>N</b> 2x  BVZN21	<b>O</b> 1x  BBSG125	<b>P</b> 3x  BBSG315
<b>Q</b> 4x  BSCH501	<b>R</b> 8x  BSCH500	<b>S</b> 6x  BVZN47	<b>T</b> 3x  BTRGJUL001
<b>U</b> 16x  BBSG196			

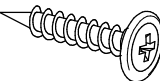
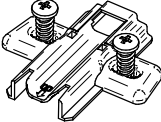
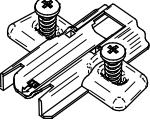

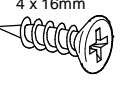
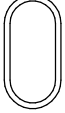
	Art. Nr.	Aantal
1	OGRJUL282	1x
2	OZIJUL281	2x
3	ORUJUL282	1x
4	OBZJUL281	1x
5	ORUJUL281	1x
6	OKOJUL282	1x
7	OLPJUL282	1x
8	OLPJUL281	1x
9	OLPJUL281	4x
10	ODRJUL281	3x

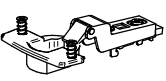
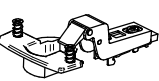

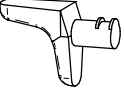
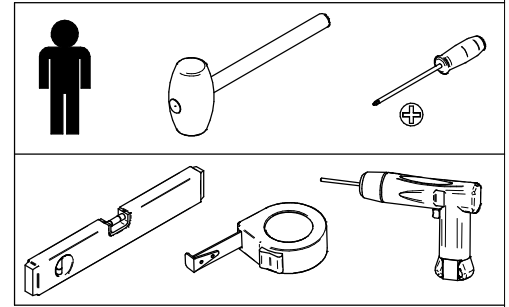
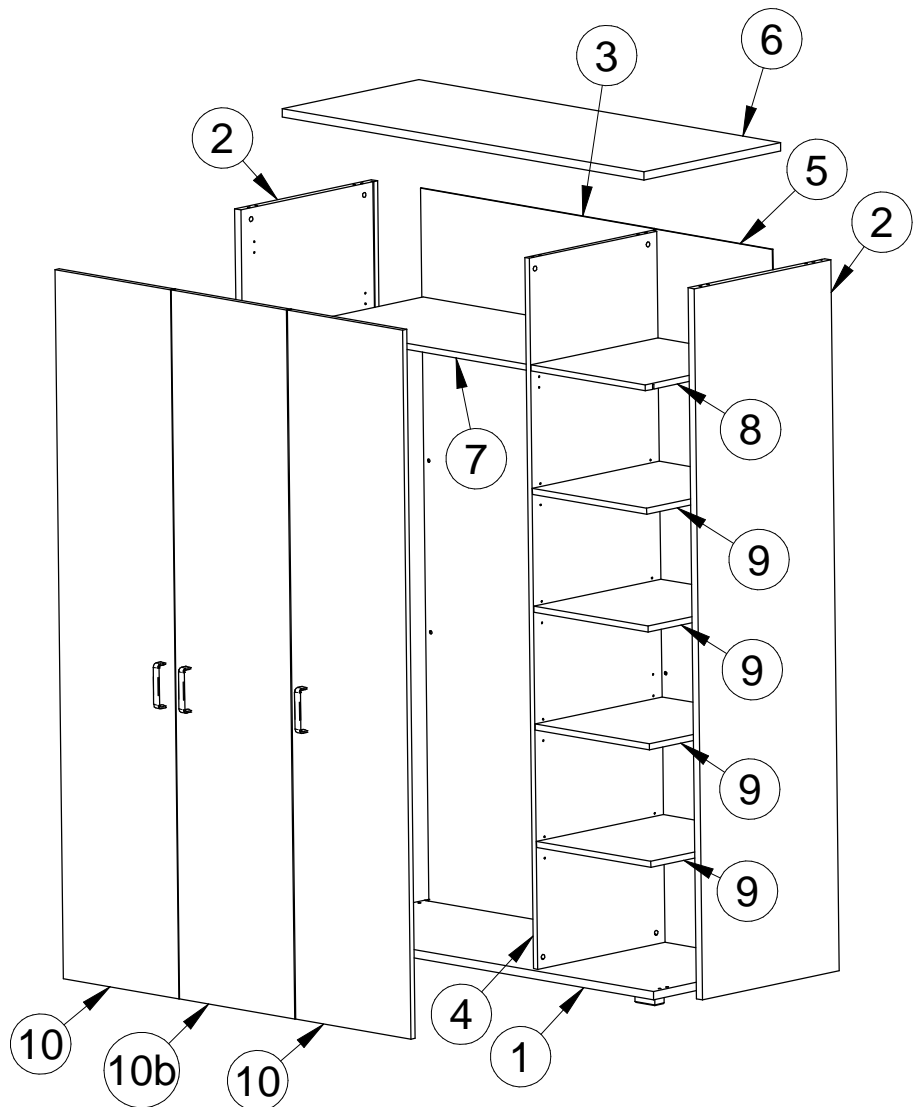
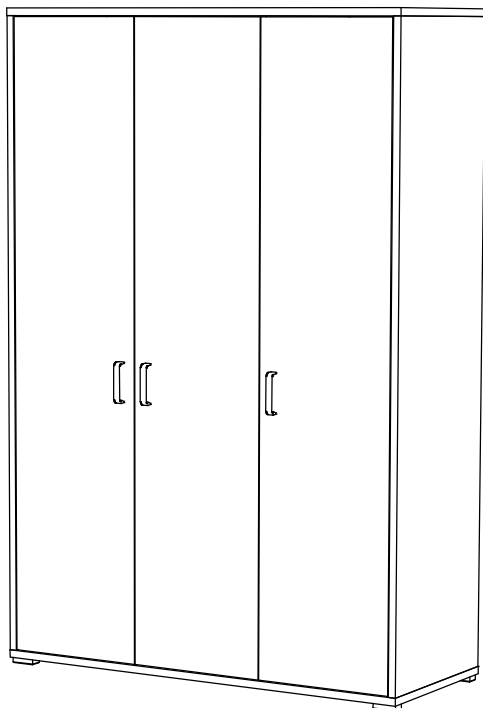
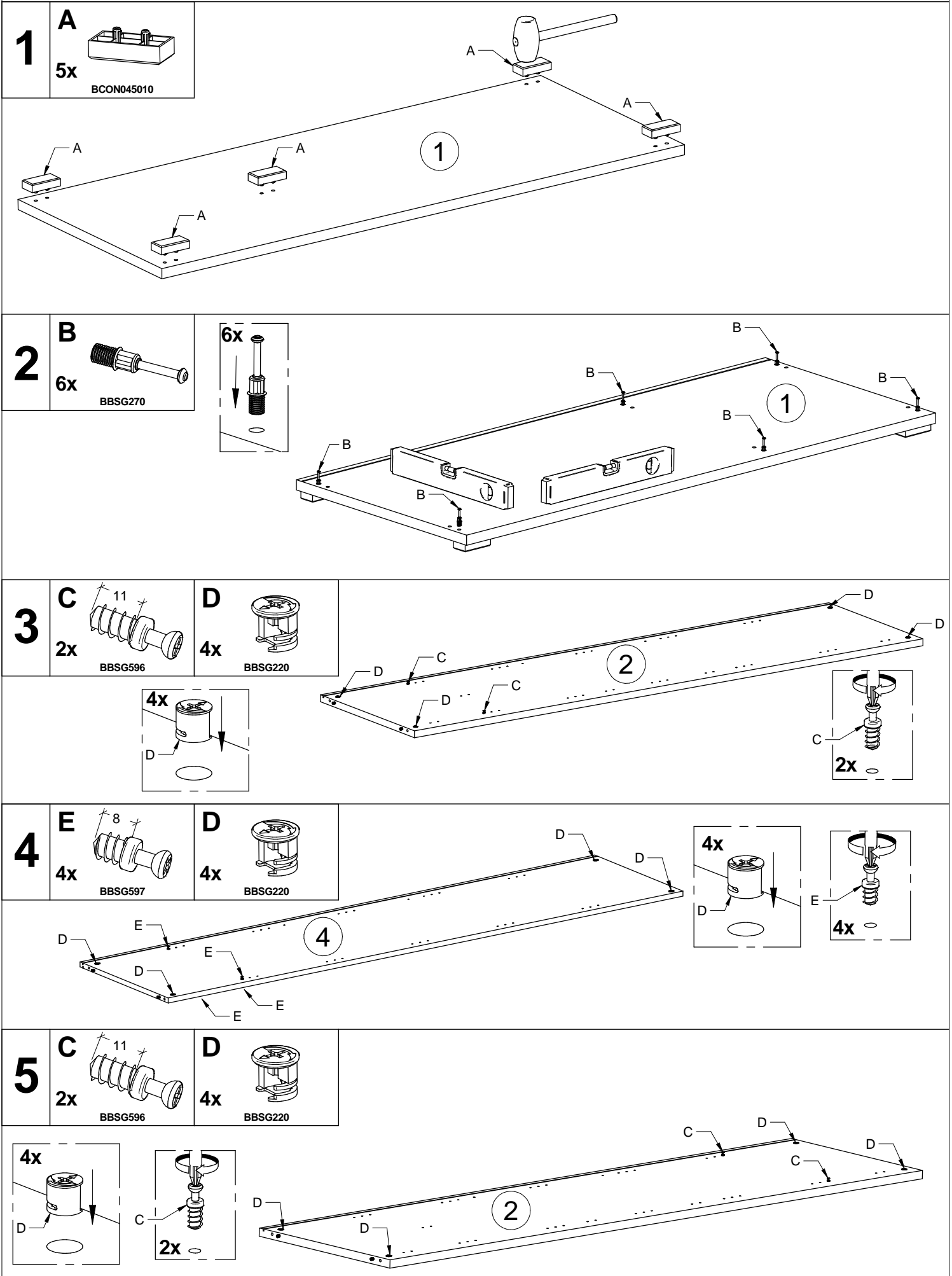

**6**

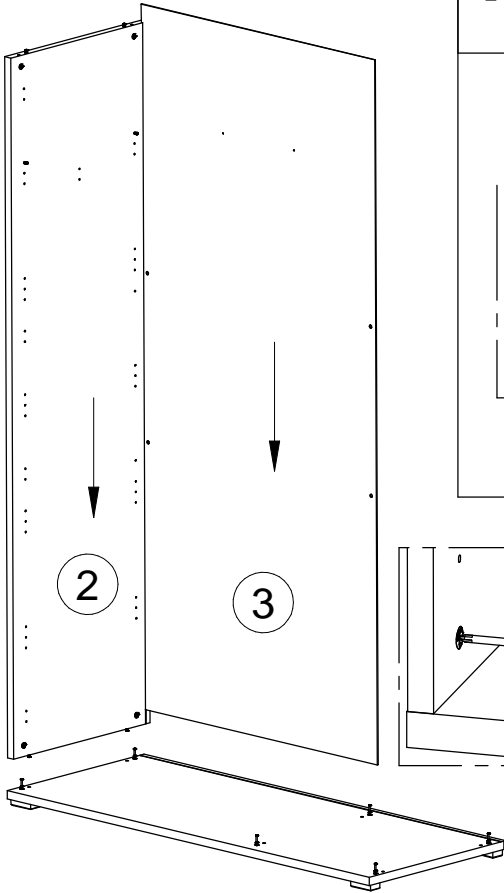

**7**

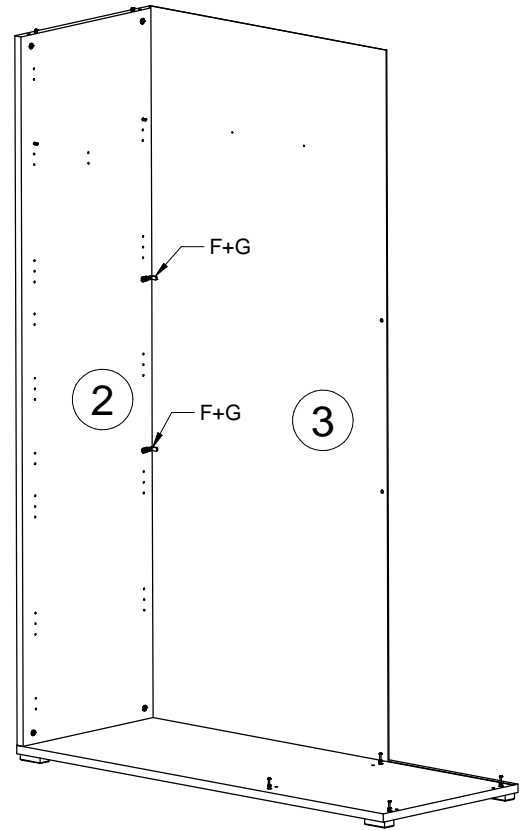
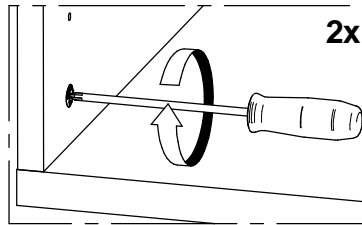
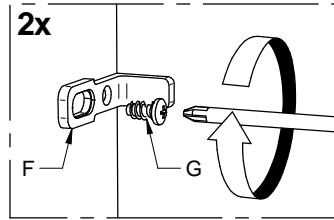
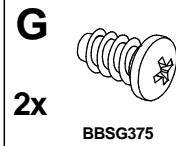
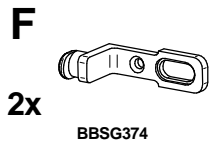

**8**

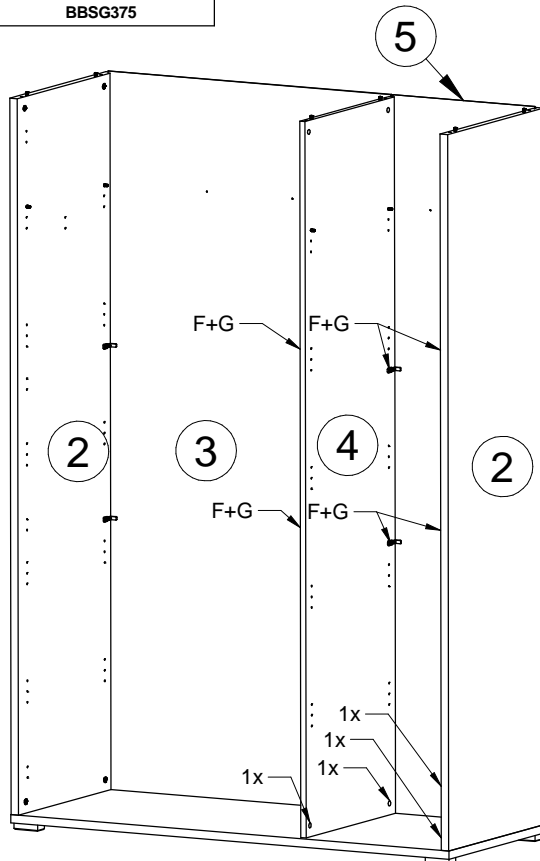
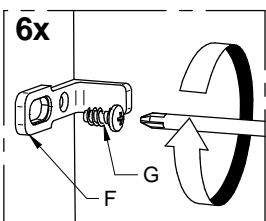
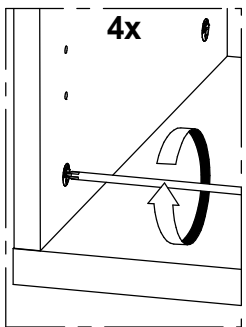
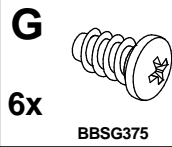
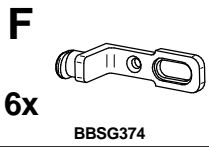

**9**

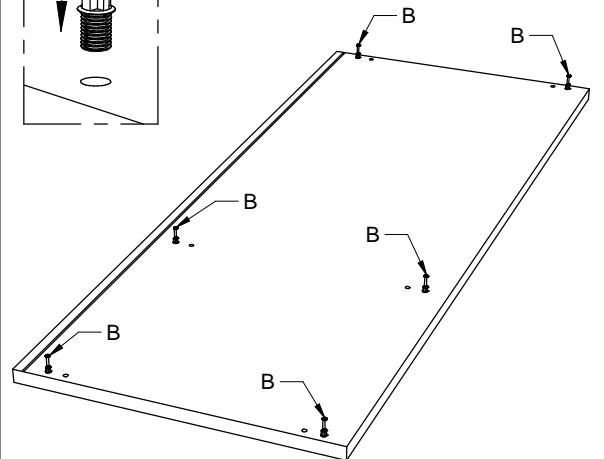
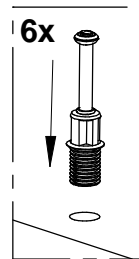
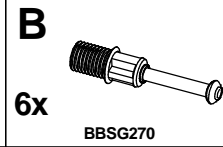

10

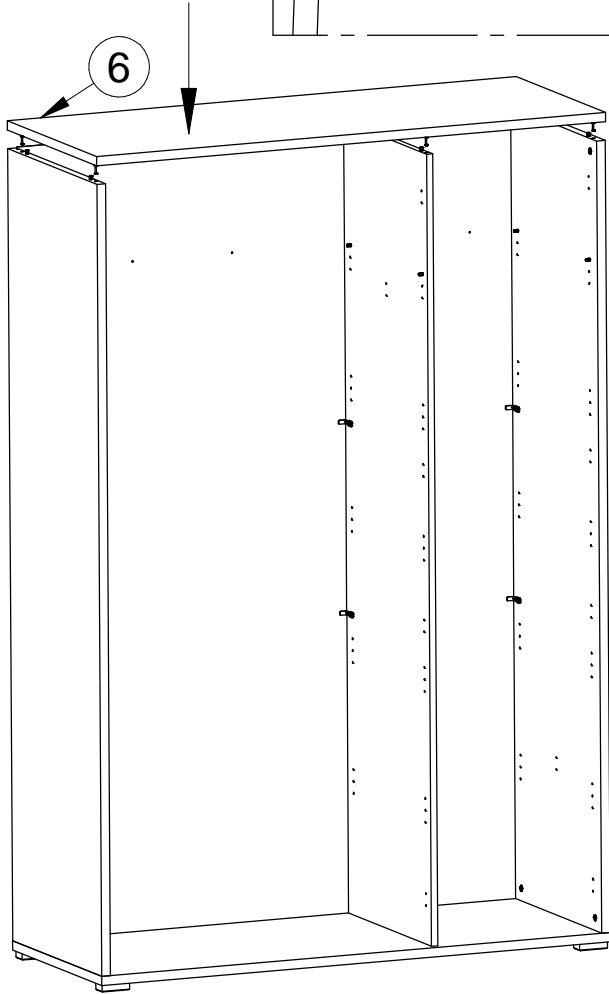
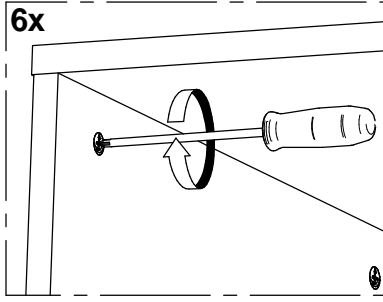

11

H  
3,5 x 16mm  
BVZN11

8x

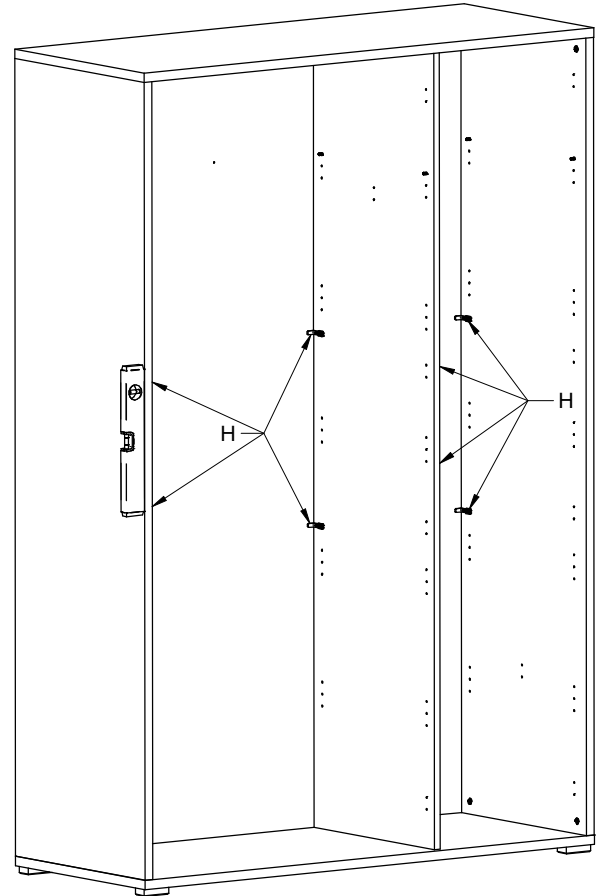
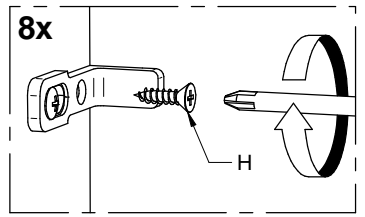

12

I  
8x  
BBSG664

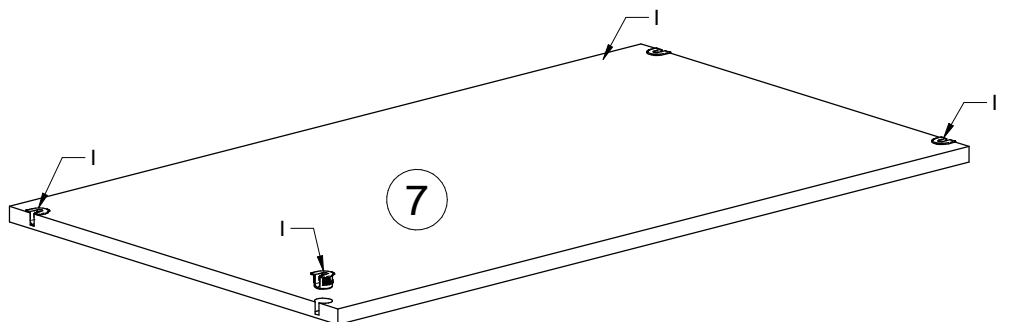
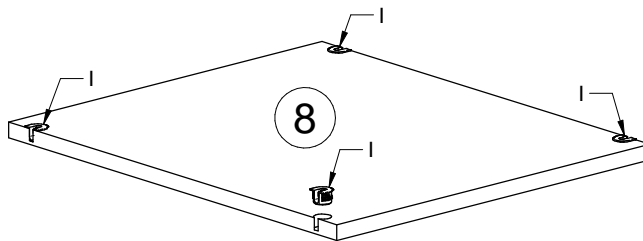
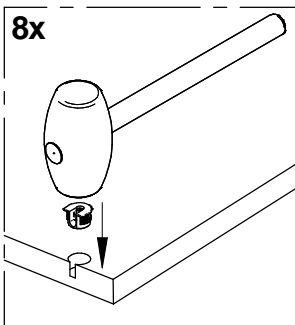

13

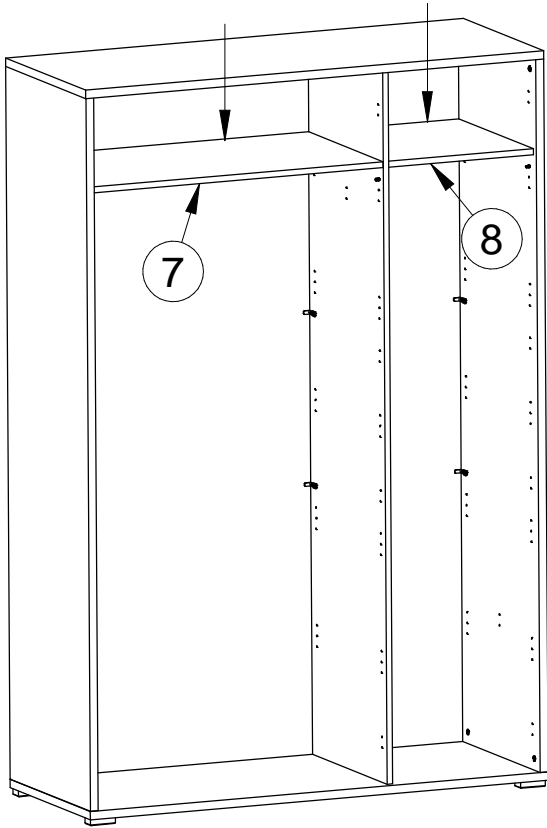

14

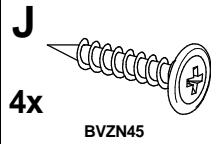

4x

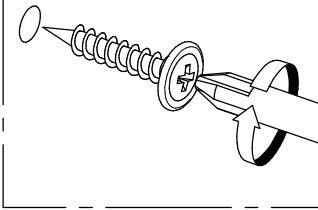

8x

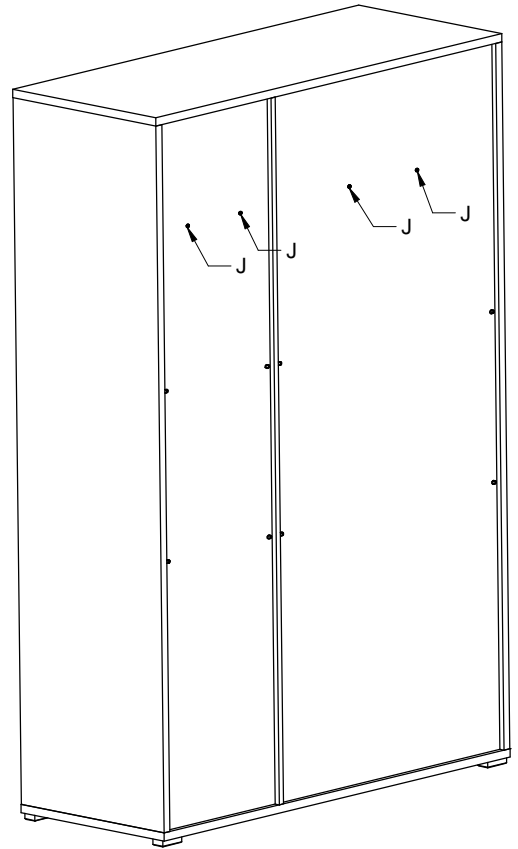
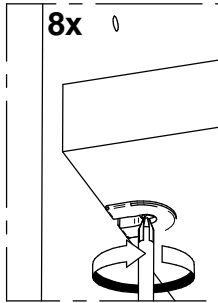

15

U

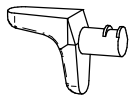

16x

BBSG196

16

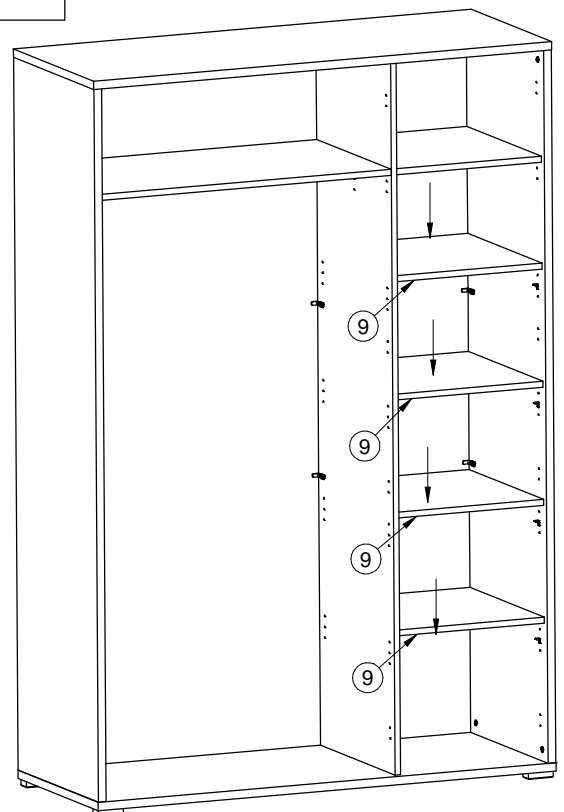
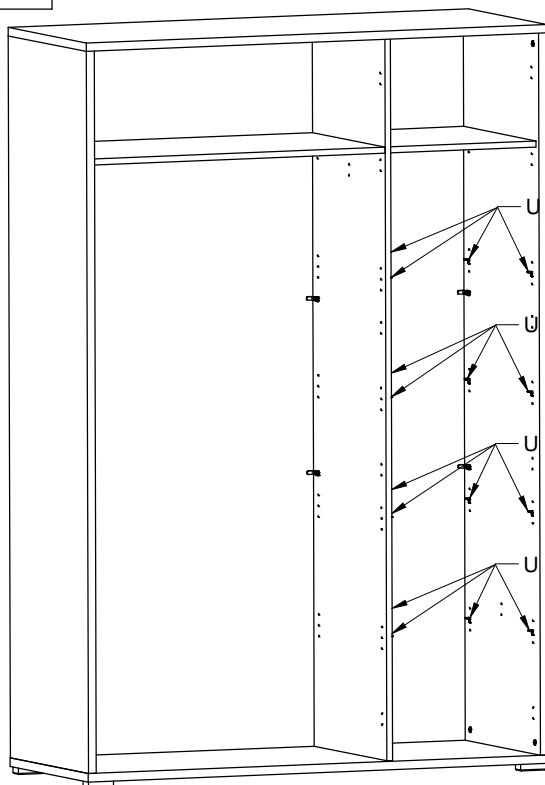
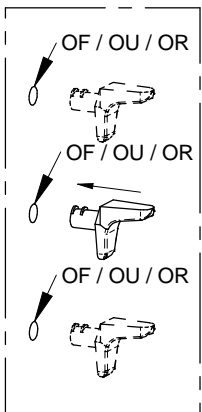

<b>17</b>	<b>K</b> 4x BSCH512	<b>L</b> 8x BSCH510	<b>M</b> 2x BBSG354	<b>N</b> 2x BVZN21 4 x 16mm	<b>O</b> 1x BBSG125

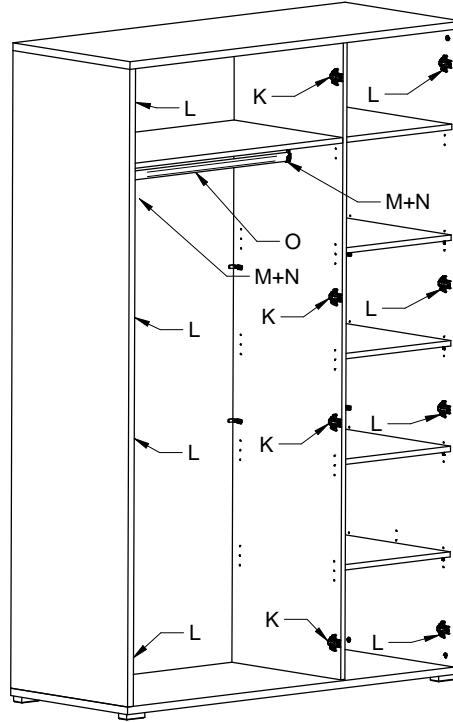
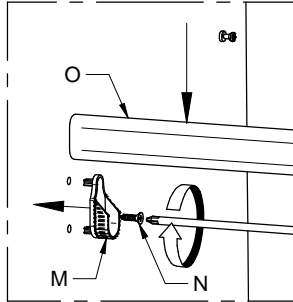
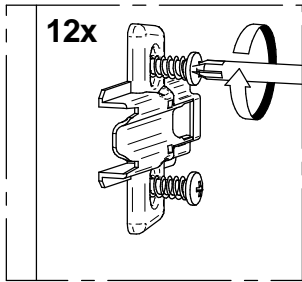

<b>18</b>	<b>P</b> 3x BBSG315

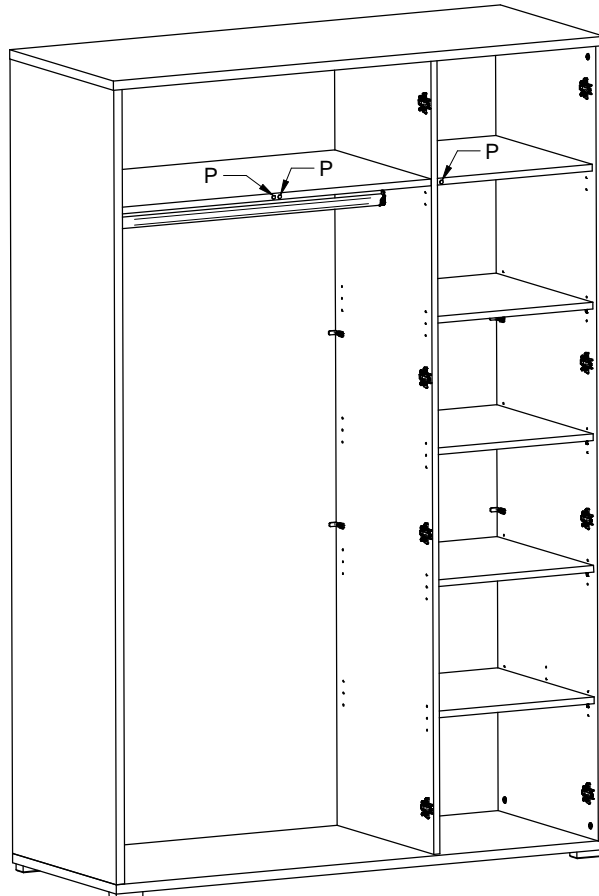

**19**

<b>Q</b> 4x BSCH501	<b>R</b> 8x BSCH500
---------------------------	---------------------------

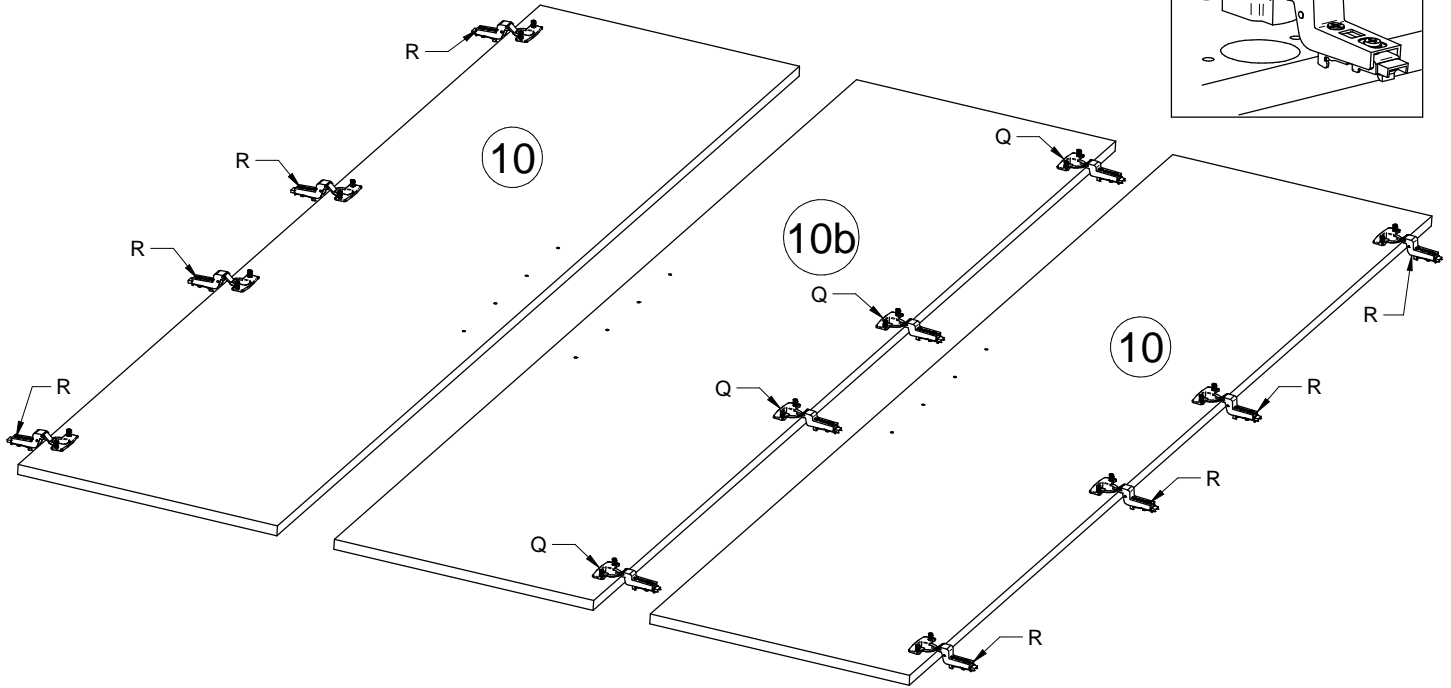
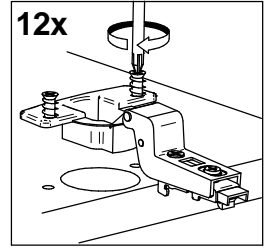

**20**

**21**

!!!Tegenhout gebruiken  
 !!!Utiliser contrebois  
 !!! Use counterwood

Ø 5mm  
 Ø 5mm  
 Ø 5mm  
 Ø 5mm

22

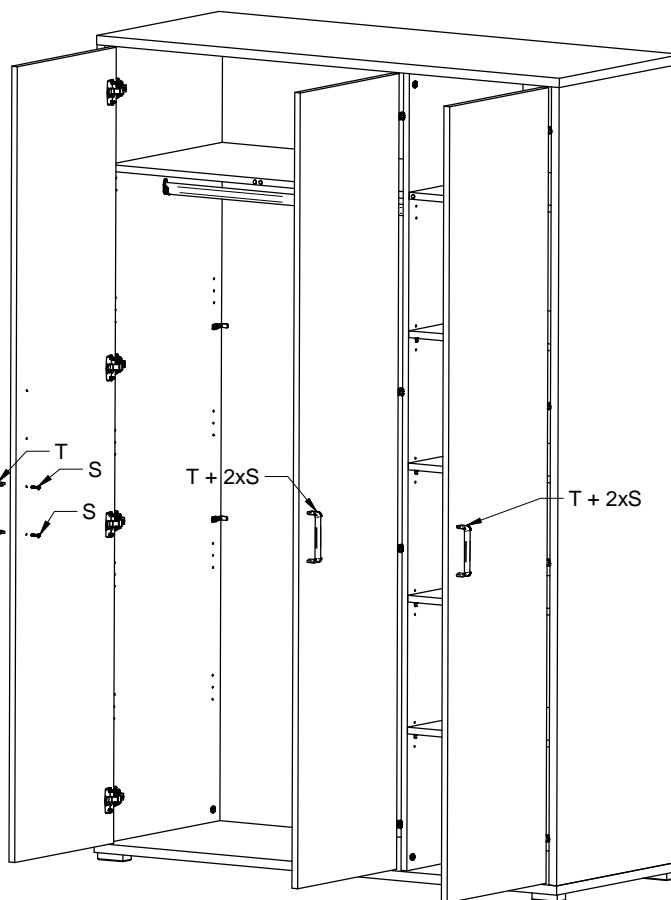
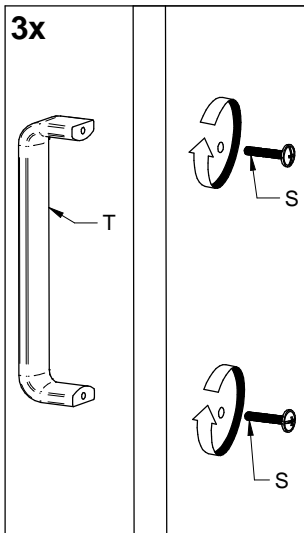
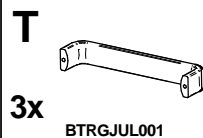
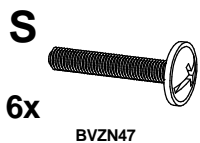

23

